

## GENERAL INFORMATION, INSTALLATION AND OPERATION SPECIFICATIONS

### 1.0 GENERAL REQUIREMENTS

- 1.1 Provide and install BoilerMagXT in accordance with manual specifications
- 1.2 All work is to be performed in neat workmanship like manner compliant with all local code authorities
- 1.3 BoilerMagXT is to be used in large properties where build-up of ferrous oxide and scale in central heating systems is prevalent

### 2.0 PRODUCT DATA

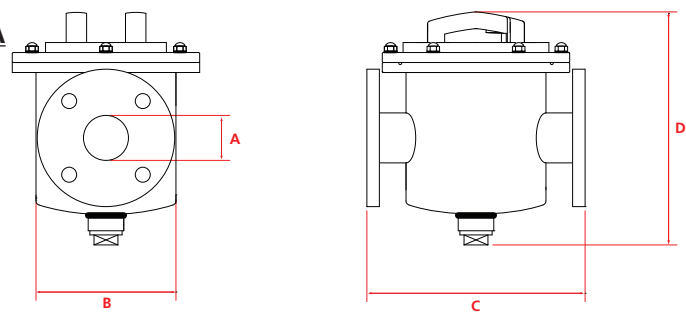

Item Code	Part No.	Inlet / Outlet A	Filter Dia. B	Dimension C	Height D	No. magnetic rods	Flow rate at 3ft/sec gallons/min. (m <sup>3</sup> /hour)	Flow rate at 5ft/sec gallons/min. (m <sup>3</sup> /hour)	Flow rate at 8ft/sec gallons/min. (m <sup>3</sup> /hour)	Weight lbs/ kgs
BMXT/1.5NPT	BMXT100/NPT	1½" NPT	4" / 100mm	7½" / 190mm	11" / 280mm	3	17 (4)	28 (6)	44 (10)	19 / 8
BMXT/2NPT	BMXT150/NPT	2" NPT	6¾" / 170mm	10¾" / 270mm	11" / 280mm	5	20 (5)	48 (11)	78 (18)	40 / 18
BMXT/2.5	BMXT150/2.5/ANSI	2½" / 63mm	6¾" / 170mm	12¾" / 315mm	11" / 280mm	5	46 (10)	77 (17)	122 (28)	44 / 20
BMXT/3	BMXT200/3/ANSI	3" / 75mm	8¾" / 220mm	14¾" / 360mm	13¼" / 335mm	7	65 (15)	110 (25)	175 (40)	82 / 37
BMXT/4	BMXT200/ANSI	4" / 100mm	8¾" / 220mm	14¾" / 380mm	13¼" / 335mm	7	120 (27)	200 (45)	315 (72)	82 / 37
BMXT/6	BMXT300HF/ANSI	6" / 150mm	12¾" / 325mm	19¼" / 490mm	16½" / 420mm	9	260 (59)	440 (100)	700 (159)	133 / 60
BMXT/8	BMXT300HF/8/ANSI	8" / 200mm	12¾" / 325mm	20¾" / 525mm	18¾" / 460mm	9	475 (108)	775 (176)	1250 (284)	140 / 64
BMXT/10*	BMXT400/10/ANSI*	10" / 250mm	16" / 406mm	30" / 760mm	29¾" / 754mm	16	750 (170)	1225 (278)	1950 (443)	190 / 86
BMXT/12*	BMXT400/12/ANSI*	12" / 300mm	16" / 406mm	30" / 760mm	29¾" / 754mm	16	1100 (250)	1780 (404)	2800 (636)	195 / 88

\* Made to order sizes

### PERFORMANCE

- Magnetic performance** 9,000 Gauss high strength
- Performance reading** On tube surface
- Magnetic material** Rare Earth Neodymium Iron Boron N42SH
- Temperature** 41° to 302°F / 5° to 150°C (212°F / 110°C if using automatic air vent)
- Operating pressure** +/- 174psi / 12 bar (145psi / 10 bar if using automatic air vent)
- Drain valve** ¾" NPT on BMXT/1.5" versions, all others 1¼"NPT

### MATERIALS/CONSTRUCTION

- Housing** 304 grade stainless steel
- Tube cartridge** 316 grade stainless steel – aerospace quality
- Other parts** 304 grade stainless steel
- Surface finish** Internal - bead blast  
External - powder coated, black
- Sealing** EPDM

### INCLUDES

Additional Automatic Air Vent that has been packaged along with unit separately. The auto-vent will automatically release the trapped air maintaining heating efficiency

### OPTIONS

High temperature Samarium Cobalt magnetic material +482°F / 250°C

### WARRANTY

Industry leading 10 years

\*\*\*GAUSS: The gauss is the unit of measurement of magnetic flux density

### 3.0 INSTALLATION

- 3.1 BoilerMagXT is typically installed on the return circuit as close to the boiler as possible. On larger systems, units may be installed elsewhere to give extra protection for radiators and pipework
- 3.2 BoilerMagXT should be located in a position which gives it adequate access above to lift out the magnets during service and maintenance
- 3.3 Access is also required to the underneath of the unit to connect a hose or hold a bucket during draining
- 3.4 Isolation valves (not supplied) should be installed for cleaning and servicing to be carried out

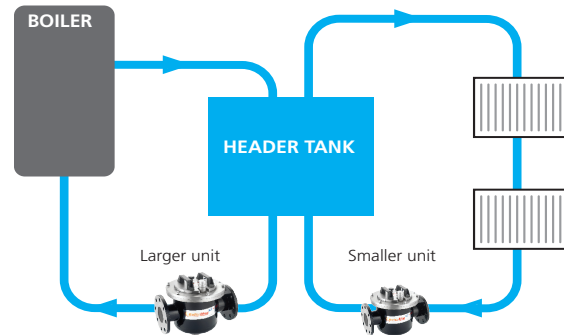

### 4.0 PRESSURE DROP DATA

1½" BMXT		
Flow (gpm)	Pressure Differential (psi)	ft of head
0	0.00	0.00
22	0.05	0.12
44	0.24	0.55
66	0.39	0.90

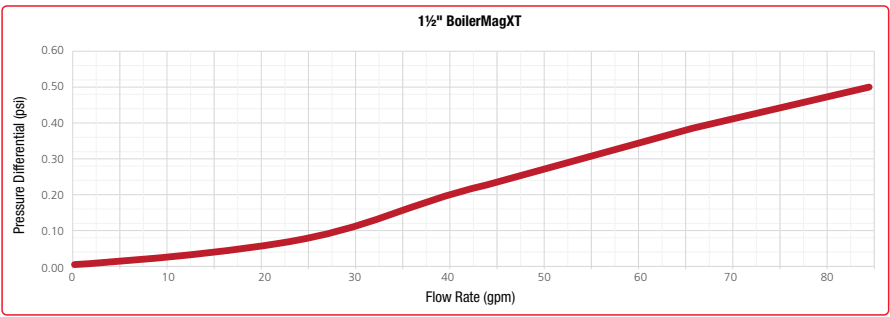

2" BMXT		
Flow (gpm)	Pressure Differential (psi)	ft of head
0	0.00	0.00
22	0.04	0.09
44	0.16	0.37
66	0.36	0.83
88	0.63	1.50

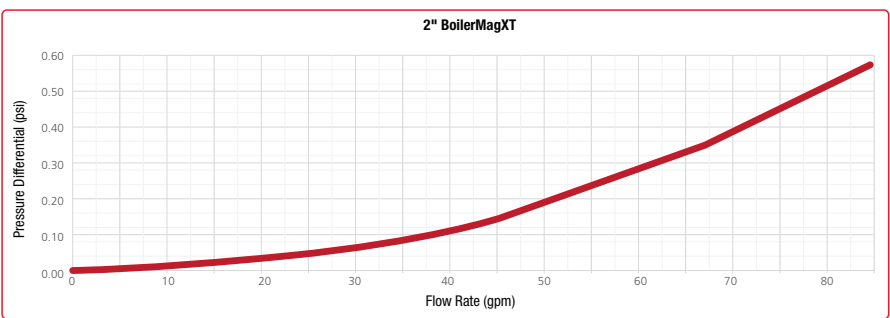

2½" BMXT		
Flow (gpm)	Pressure Differential (psi)	ft of head
0	0.00	0.00
22	0.03	0.07
44	0.12	0.28
66	0.16	0.37
88	0.29	0.67
110	0.40	0.92
198	0.85	1.96

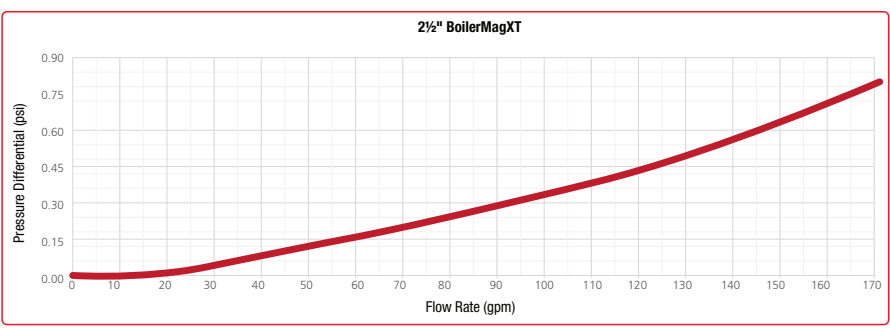

3" BMXT		
Flow (gpm)	Pressure Differential (psi)	ft of head
0	0.00	0.00
22	0.01	0.02
44	0.03	0.05
66	0.06	0.14
88	0.11	0.25
110	0.17	0.39
198	0.69	1.59

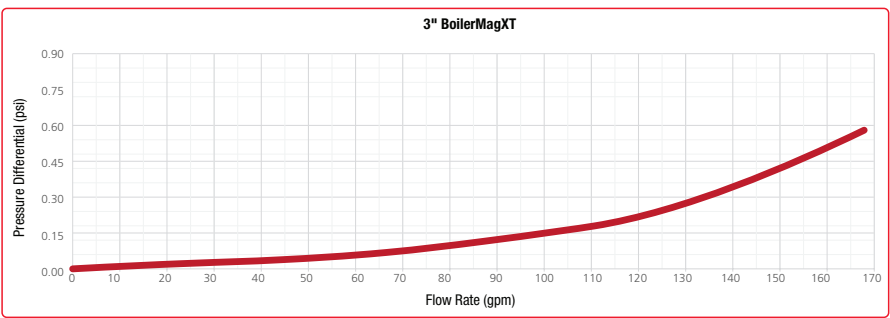

4" BMXT		
Flow (gpm)	Pressure Differential (psi)	ft of head
0	0.00	0.00
22	0.00	0.00
44	0.01	0.02
66	0.02	0.05
88	0.03	0.05
110	0.05	0.12
198	0.15	0.35
220	0.21	0.48
242	0.26	0.60
308	0.42	0.97

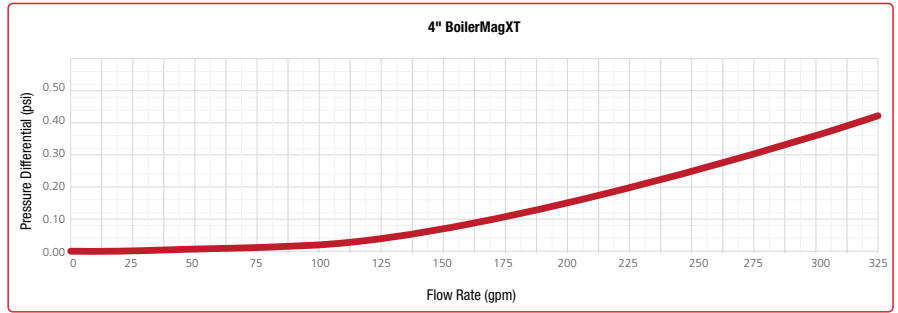

6" BMXT		
Flow (gpm)	Pressure Differential (psi)	ft of head
0	0.00	0.00
22	0.00	0.00
44	0.00	0.00
66	0.00	0.00
88	0.00	0.00
110	0.01	0.02
198	0.02	0.05
220	0.02	0.05
242	0.03	0.05
308	0.05	0.12
374	0.07	0.16
616	0.30	0.69
678	0.47	1.08

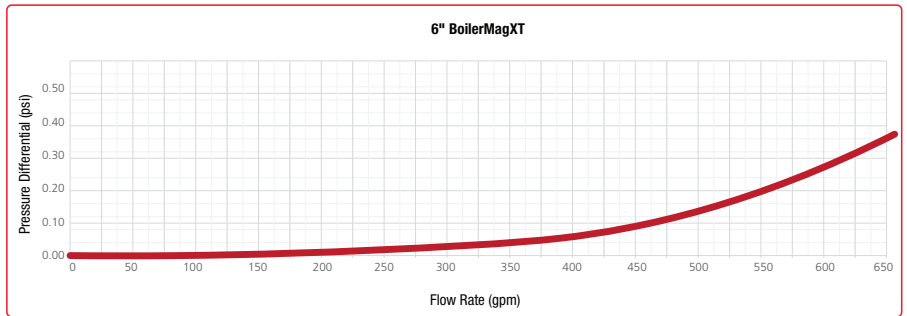

8" BMXT		
Flow (gpm)	Pressure Differential (psi)	ft of head
0	0.00	0.00
22	0.00	0.00
44	0.00	0.00
66	0.00	0.00
88	0.00	0.00
110	0.00	0.00
198	0.01	0.02
220	0.02	0.05
242	0.02	0.05
308	0.03	0.05
374	0.04	0.09
616	0.12	0.28
678	0.16	0.37
814	0.21	0.48
968	0.31	0.72
1170	0.43	0.99

